

The Coyote popup display system combines strength, reliability, and style. It is lightweight and easy to use. It uses "Rare Earth Neo Magnets" to make it simple to erect and take down.



Coyote shown fully extended with graphic.

features & benefits

- Single or double-sided
- Quick to set up
- Easy to store and ship
- Collapses to a fraction its full size
- Molded case for easy transportation
- Available in curved or straight configurations

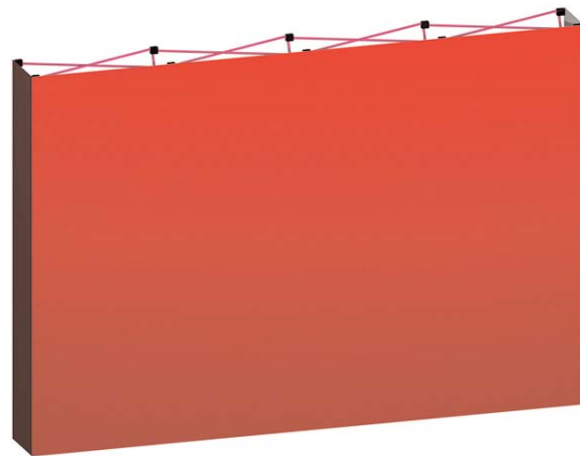

Coyote with a straight frame

Panel Sizes	Unit Heights	additional info
<p>Widths:</p> <p>Inside Curve: 26.5" / 673.1mm</p> <p>Outside Curve: 31.75" / 806.45mm</p> <p>End Cap: 23.5" / 596.9mm</p> <p>Straight Panel: 28.845" / 732.66mm</p> <p>Straight end cap: 15" / 381mm</p>	<p>Heights:</p> <p>1 Quad: 30.625" / 777.875mm</p> <p>2 Quad: 59.375" / 1508.125mm</p> <p>3 Quad: 87.5625" / 2224.08mm</p>	<p>Shipping Dimensions:</p> <p>WeightL: Varies per kit</p> <p>18" x 27.75" x 39.25" / 457.2mm x 704.85mm / 996.95</p> <p>Available Option: Case to counter conversion Bubble panel Internal shelf kit</p>

We are continually improving and modifying our product range and reserve the right to vary the specifications without prior notice. All dimensions and weights quoted are approximate and we accept no responsibility for variance.

Assembly Instructions

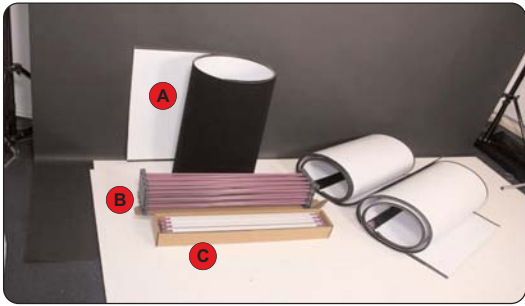

Kit includes: (A) Panels (B) Coyote pop up (C) Magnetic channel bars



1. Unpack the system from the case.



2. Lay the system down on its side and begin to pull upwards.



3. Pull upwards



4. When Coyote is fully extended, connect the two magnetic locking arms.

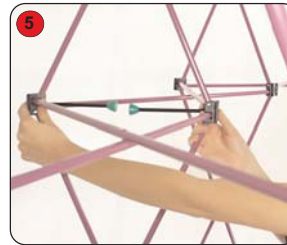

7. Place the channel bars onto the frame.



8. There will be enough magnetic channel bars to cover the front of the system and the back two outer edges of the frame.



9. When all of the magnetic channel bars are in place, you can hang your panels starting with the end caps.



10. The panels should hang evenly over the channel bars.



11. Repeat step 10



12. Repeat step 10



13. Repeat step 10. Reverse steps 10 through 1 to pack.

Assembly Instructions

All straights are 12.75" / 323.85mm deep

30.5" / 774.7mm

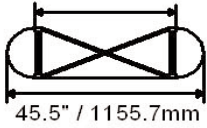

59.5" / 1511.3mm

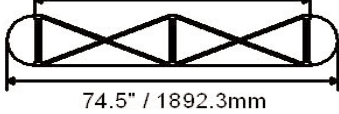

88.25" / 2241.55mm



117.25" / 2978.15mm



33" / 838.2mm

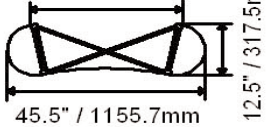

12.5" / 317.5mm

62.75" / 1593.85mm

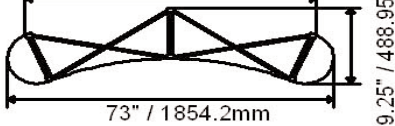

19.25" / 488.95mm

89.25" / 2266.95mm

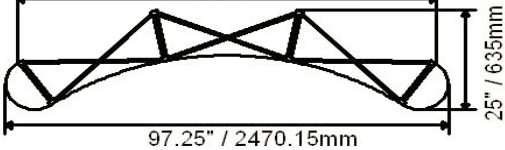

25" / 635mm

113" / 2870.2mm

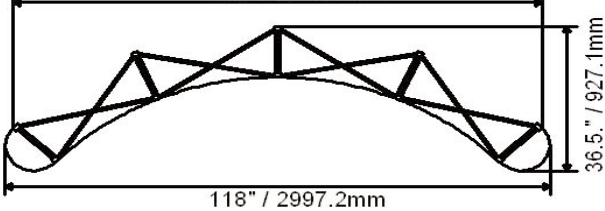

36.5" / 927.1mm

225.25" / 5721.35mm

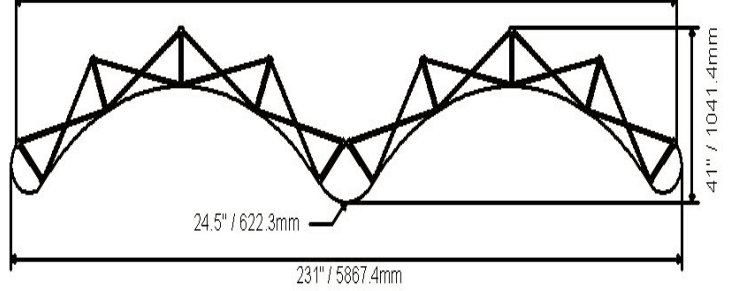

217.75" / 5530.85mm

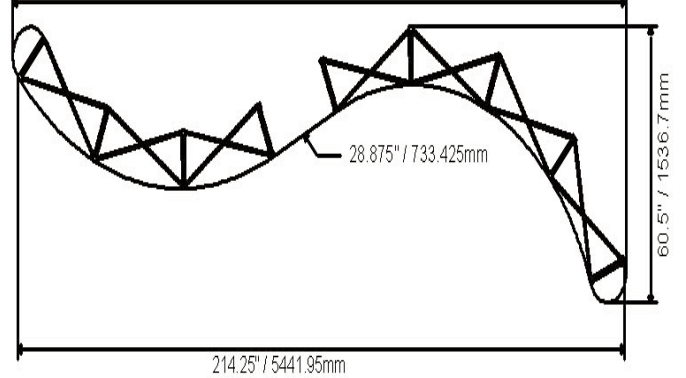

184" / 4673.6mm

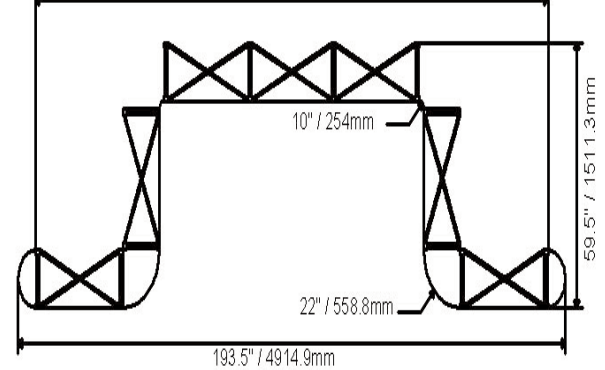

113" / 2870.2mm

